

# Oilwind 1910 - 2010

---

Providing quality fishing industrial  
tools for a century

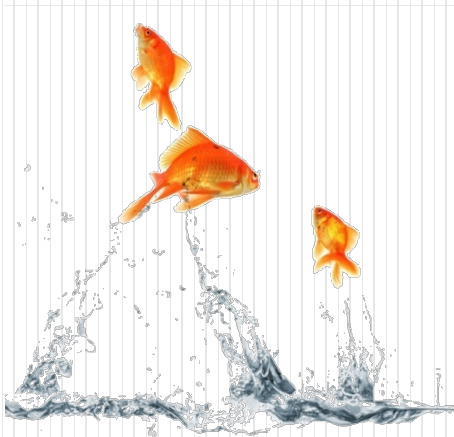

# History

---

Oilwind was founded in 1910 by Harald Joensen. In 1957 the corporation set new goals. The main goal was to develop **environmental-friendly fishing equipment**. Today Oilwind provides innovative and effective systems to the fishing industry along with environmentally sustainable solutions.

## Pollution and Co<sup>2</sup> emission

The reason why we in 1957 started developing environmentally friendly fishing equipment was because we saw the need to protect our environment from pollution and damaged sea bed.

Fishing with our Jigging machines and using our Line fishery is one of the most environmental friendly fishing ways.

Oil consumption for trawlers

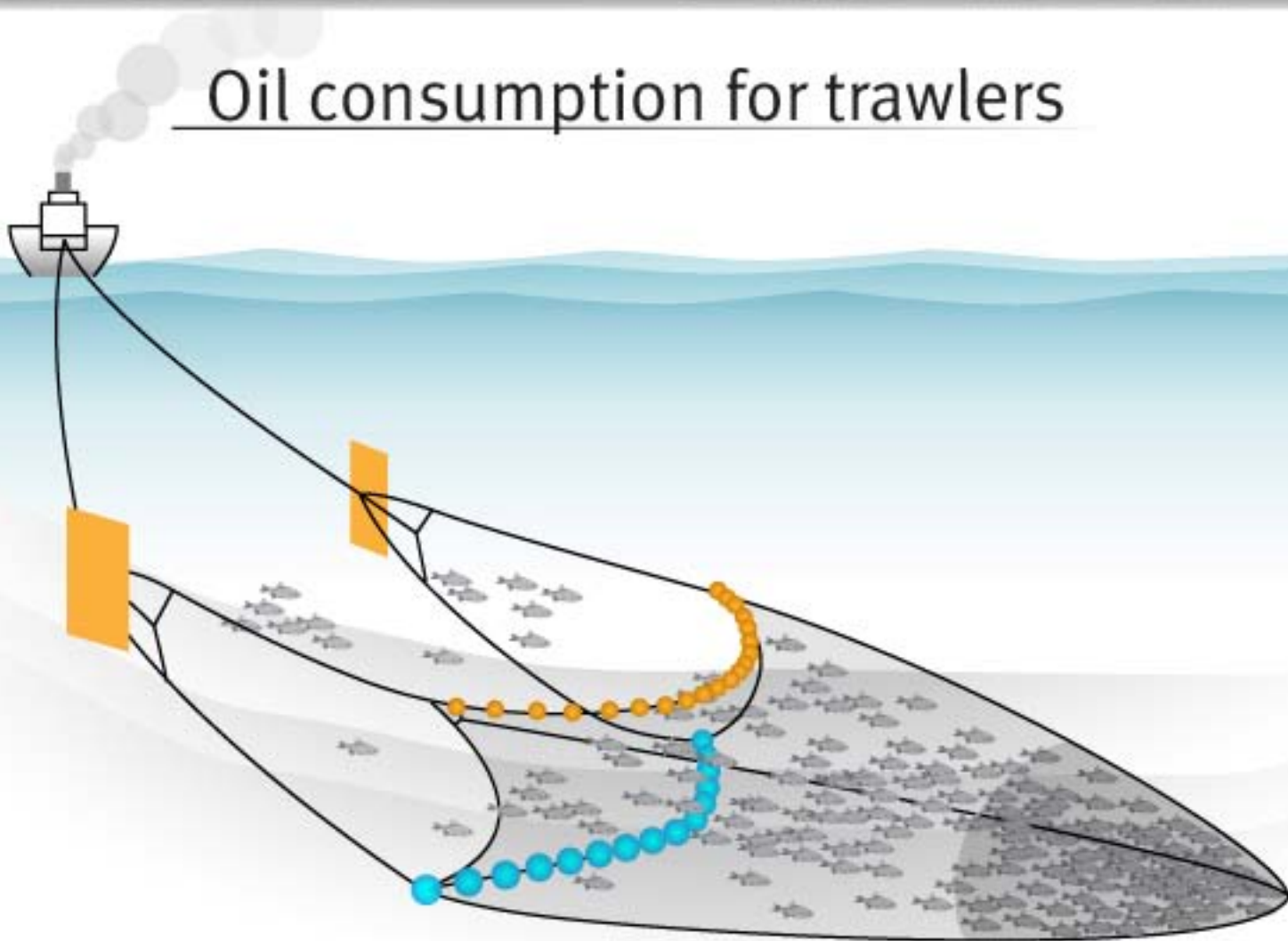

## Oil consumption for trawlers

Oil price \$0,35



Trawlers:  
18% of catch-value goes to oil

Oil price \$1,0

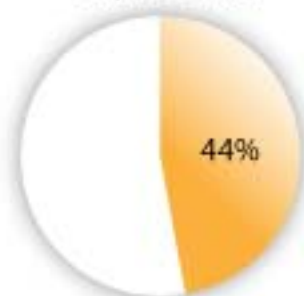

Trawlers:  
44% of catch-value goes to oil

Litres of oil used to catch one kilo fish

Deep Water Trawlers



Factorytrawlers



Small Trawlers



# Oil consumption for long-liners

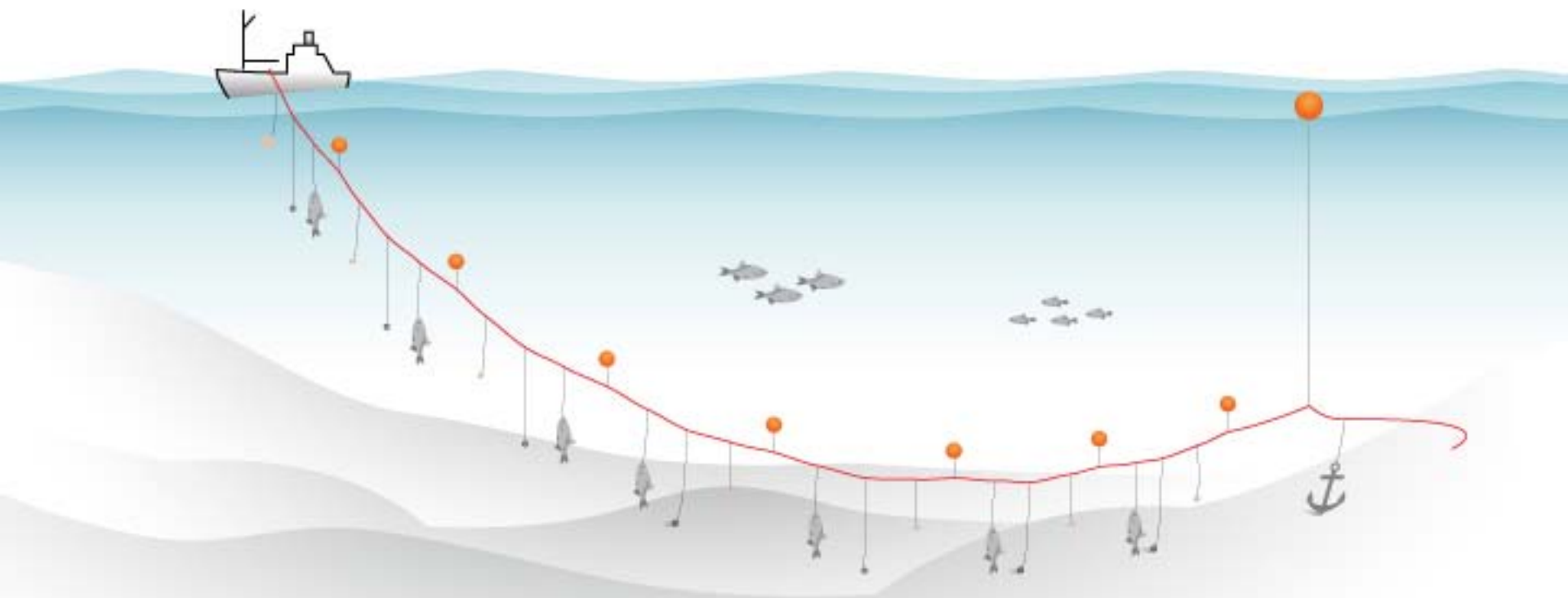

## Oil consumption for long-liners

Oil price \$0,35



Long Liners:  
5% of catch-value goes to oil

Oil price \$1,0



Long Liners:  
12,5% of catch-value goes to oil

Litres of oil used to catch one kilo fish

Long Liners



# Co<sup>2</sup> emission

We need to save our planet





# Sea bed with Trawl-setting

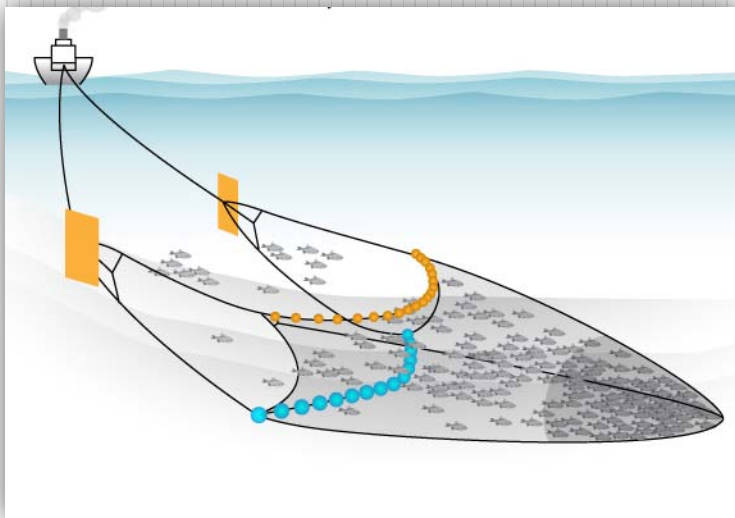

With trawl-fishing, the sea bed and corals will look like this.

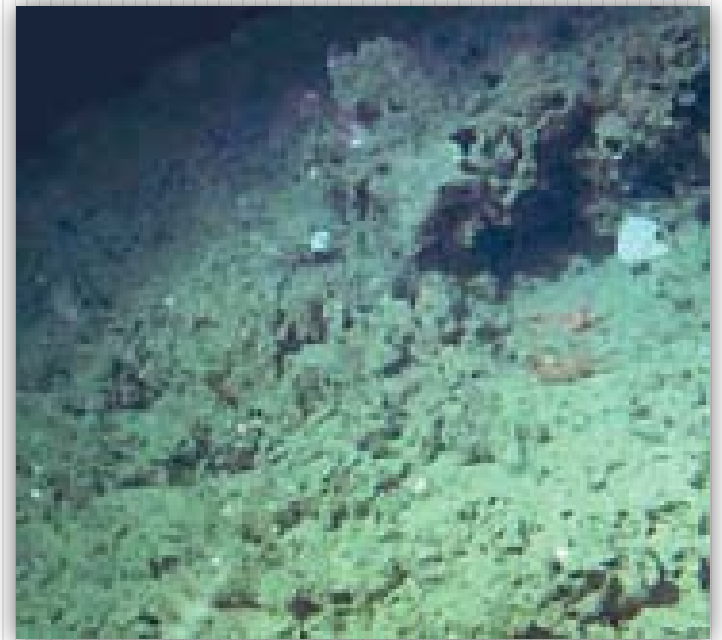

# Sea bed with Line-setting

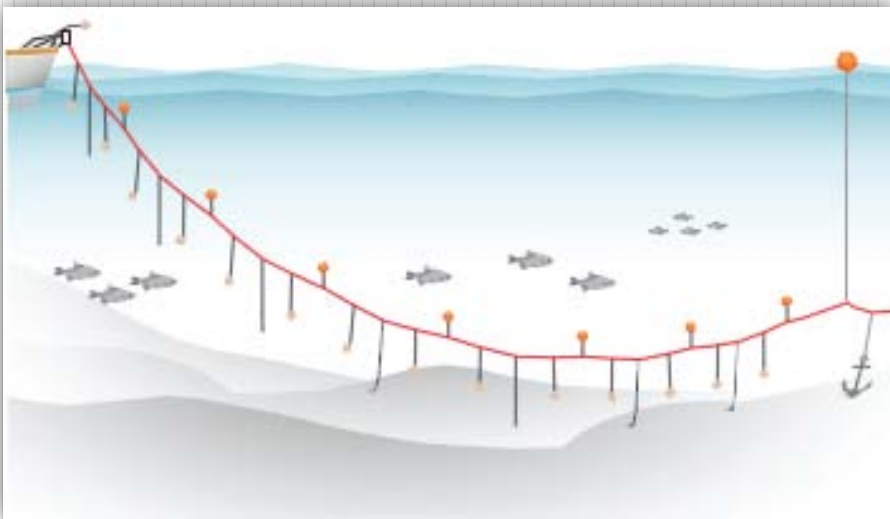

With line-fishing, the sea bed and corals are untouched.



# Line-setting

With long-line setting you are considering the future generations.

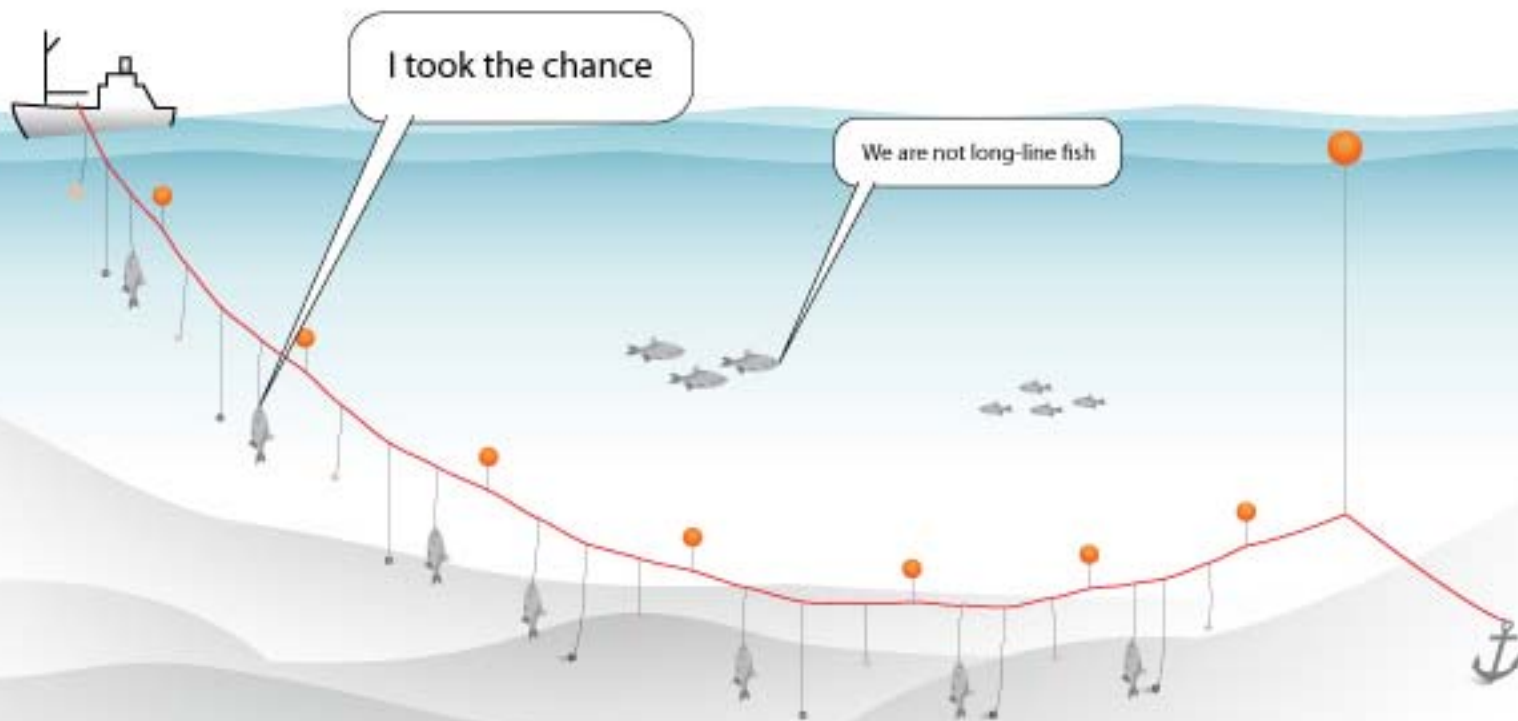

Line-fishing does not catch all the fish in the area you are fishing

# The best quality

With our longline system and our jigging machine, you will get the best quality fish and better prices.



This fish is caught with our line system

# Trawl-fishing

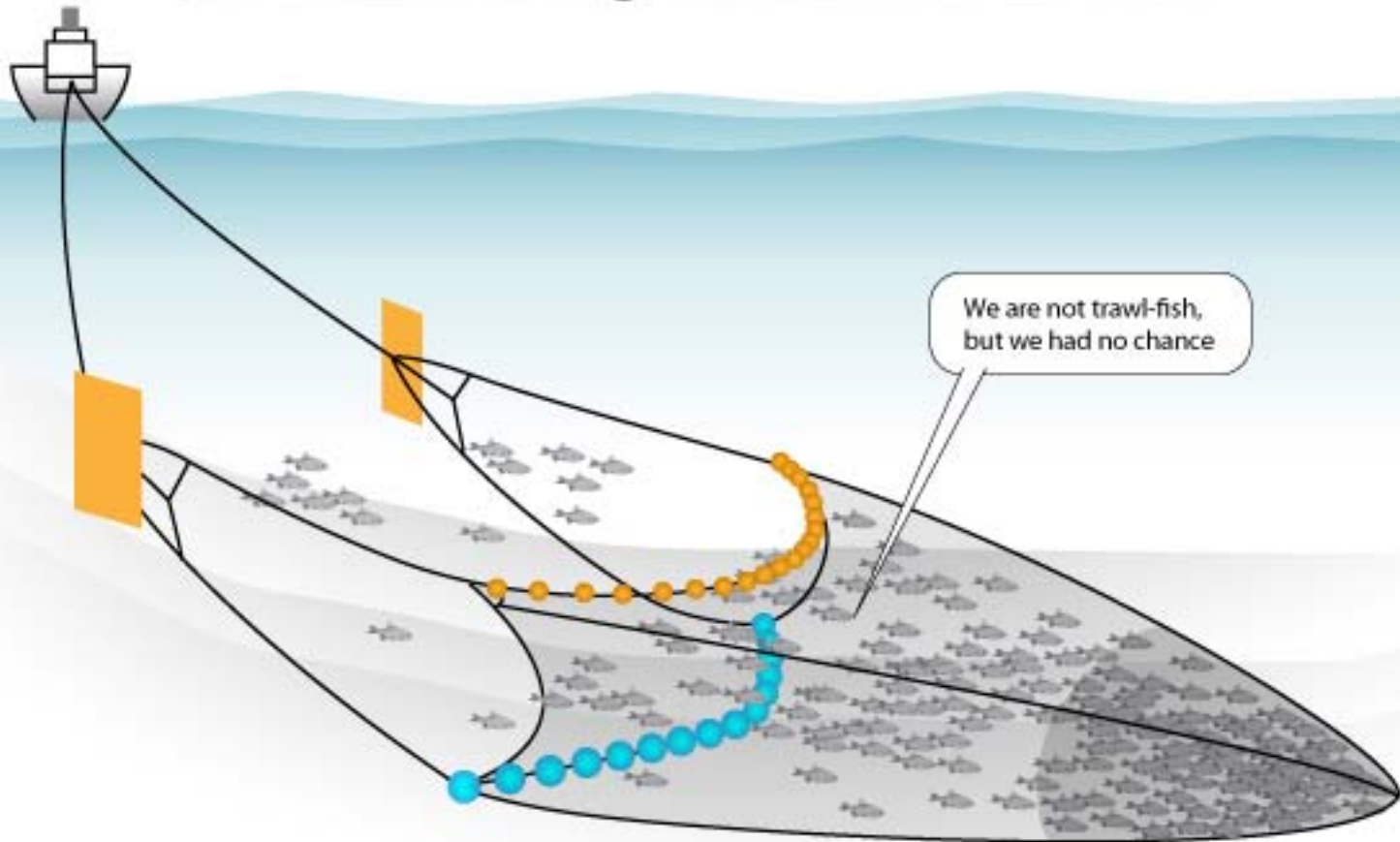

Trawl-fishing can catch all the fish

# Net fishing – Bad quality and bad price

The fish that are caught with nets have a bad quality. This is because the fish dies shortly after being caught in the nets. When the fish dies its blood runs out into the meat and makes it bad.



This fish is caught with a net.

# Ghost nets

A huge problem with nets lost at sea, is that they do not decompose. The net flows at the surface until it is so full with fish, that it sinks to bottom. There it lies until the fish has rotten away. When the net is empty, it floats to the surface and process will start again.



# Products – Jigging Machine

The first product to be developed was the hand jigging machine.





# Jigging Machine

During the time period between 1960 to 1970 the hydraulic jigging machine was developed.

One man can manage up to two manual jigging machines.

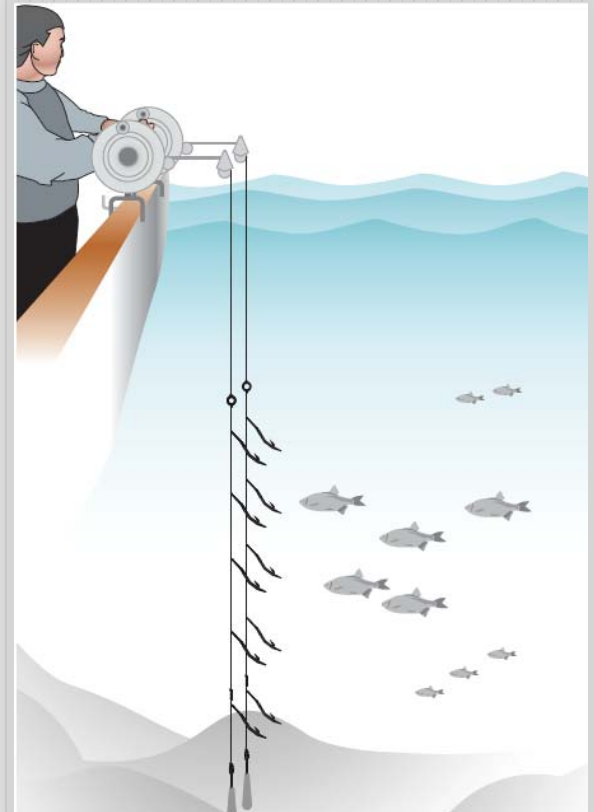

# Jigging Machine

From 1970 to 1975 Oilwind started developing a hydraulic computer controlled jigging machine. It was a major breakthrough when the first hydraulic computer controlled jigging machine arrived on the market in 1975.



# Jigging Machine

The biggest breakthrough in the history of Oilwind was in 1990 when the new Electric-computer controlled Jigging machine arrived on the market.



# Jigging Machine

One man can  
manage four  
Electric - Computer  
Controlled Jigging  
Machine

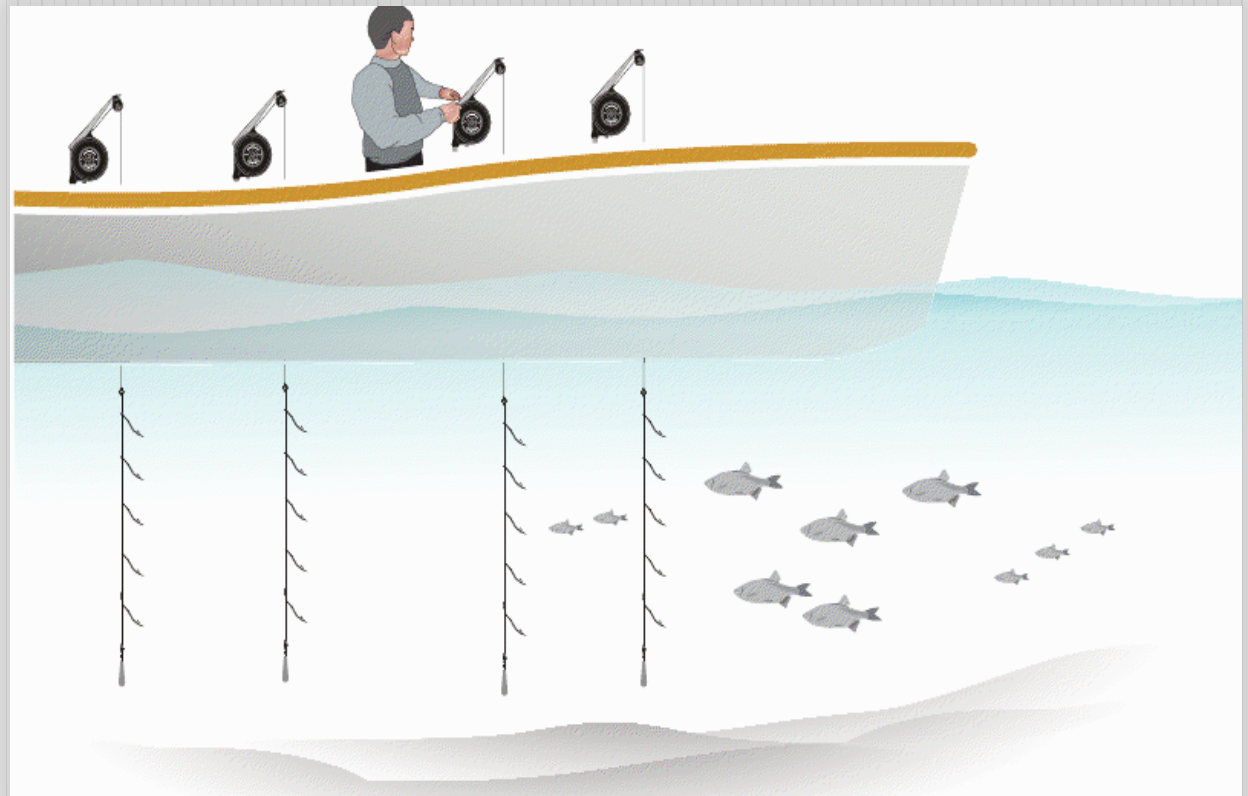

## Products - Autoline System

The last couple of years Oilwind has used a lot of resources to develop a new technology inside line fishing and the first Autoline systems arrived on the market in 2006.

This technology has been revolutionary for all line fishing. This new fishing system was developed in a way that makes it possible for one man to set out 6000 hooks per hour.



# Autoline System

With Autoline longline system the hooks are transferred through brushes that will clean the hooks for bait and then the hooks are gathered in one magazine. Each magazine takes around 300 hooks.

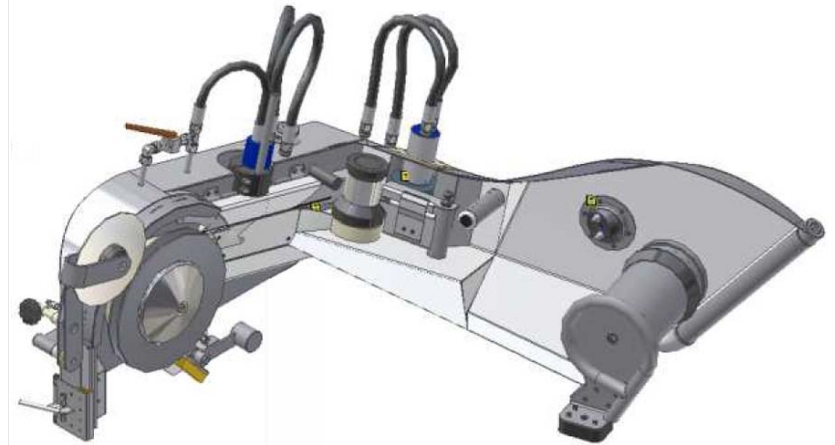

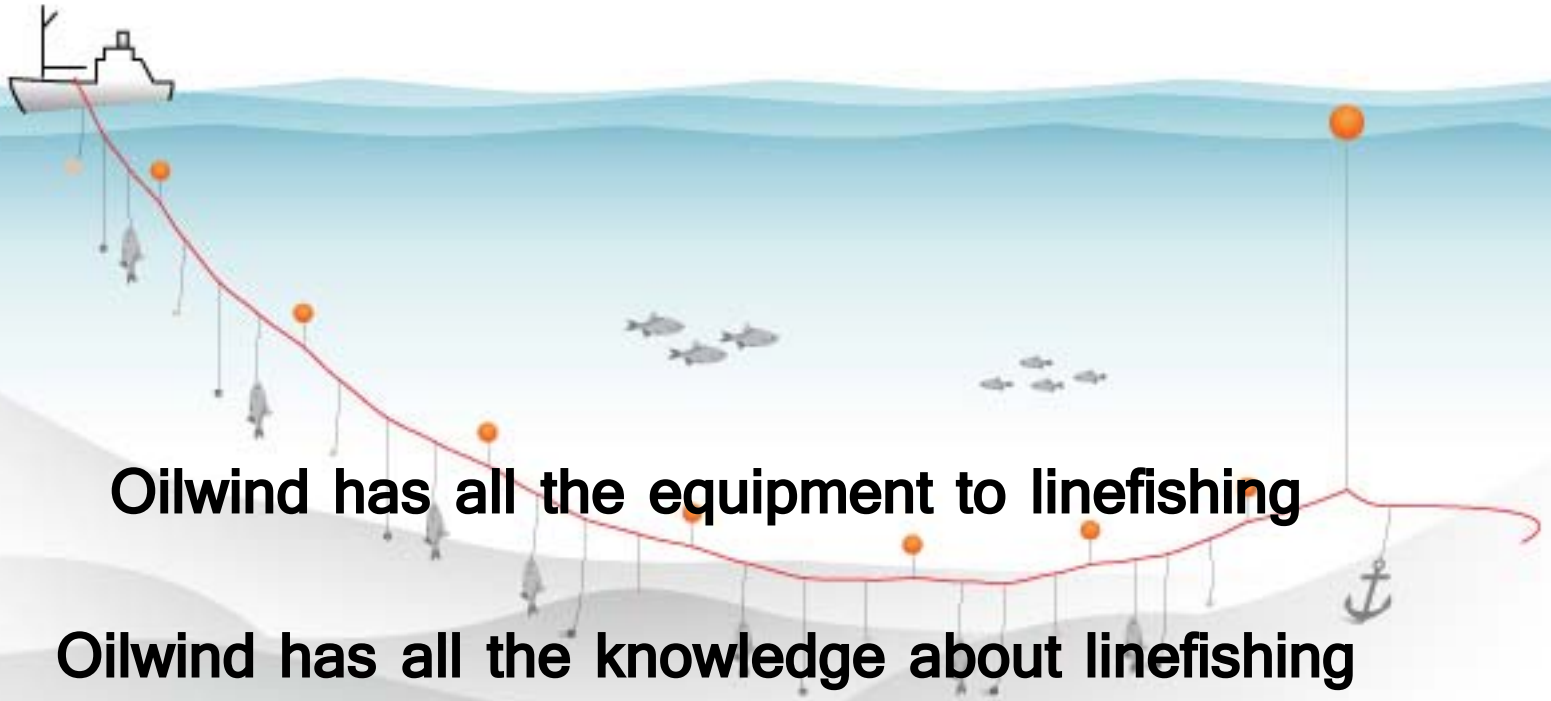

**Oilwind has all the equipment to linefishing**

**Oilwind has all the knowledge about linefishing**

**Oilwind can educate fisherman to longline fishing**